







**CL.1 Wall valve clockwise closing cold 1/2" - Chrome**

CL.1

36 617 706



- with WAVES structure
- rosette 60 x 60 mm
- with cold marking
- head part with cut-to-length spindle and sleeve

	Chrome	36 617 706-00
	Brushed Platinum	36 617 706-06
	Dark Chrome	36 617 706-19
	Brushed Champagne (22kt Gold)	36 617 706-46
	Champagne (22kt Gold)	36 617 706-47
	Brushed Dark Platinum	36 617 706-99

**Required miscellaneous**

	<b>Wall valve 1/2" -</b> •max. recess depth 150 mm •min. recess depth 105 mm	35 607 970-90 0010
---	--	-----------------------

36 617 706

mm [inches]



Codes & Standards

ADA

ASME  
A112.18.1/CSA  
B125.1

Certificates

DVGW\_DW-  
6501DN0116.

IAPMO\_4976 (1).

LGA\_29931.

WRAS\_2010066.

LGA\_29932.

36 617 706

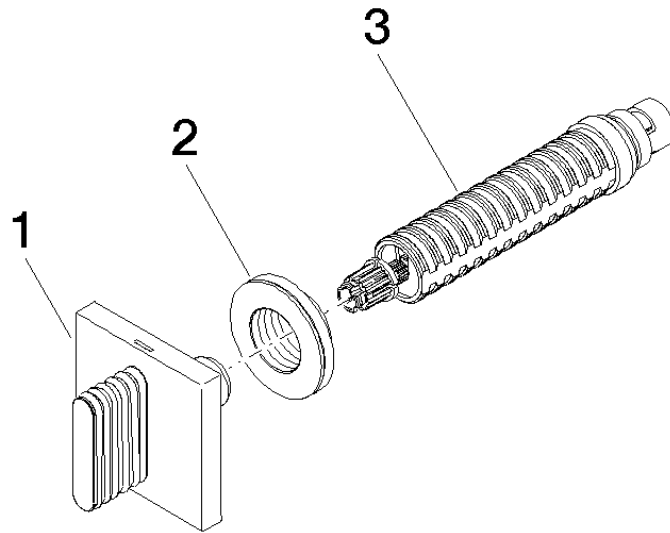

### Spare parts list

No.	Item Number	Name	Quantity used	Delivery time
1	90 20 70 055 02-00	handle ( cold )	1	10
2	09 21 02 108 90	disc	1	60
3	90 90 03 143 00 90	top	1	2